

角の大きさ

角の大きさを測る [3]

月 日 時 分 ~ 時 分

名前

問

次の角の大きさを分度器を使って測りましょう。

①

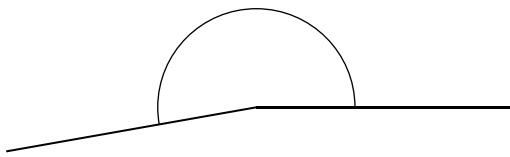

②

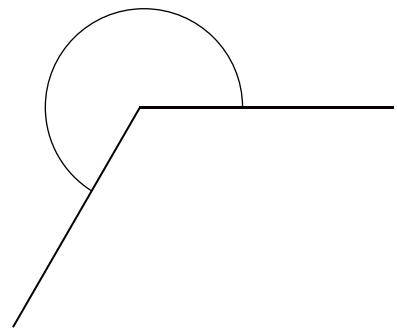

③

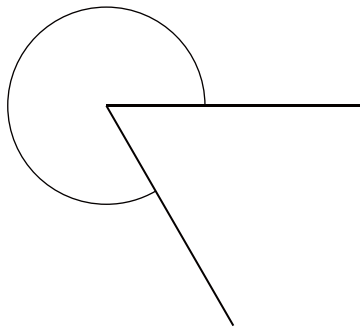

④

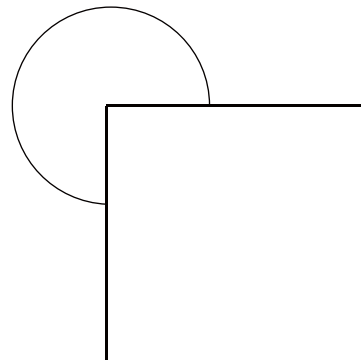

⑤

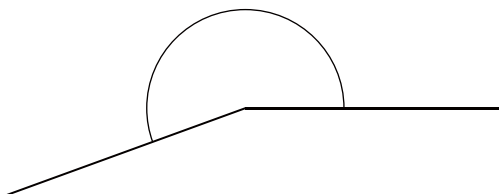

⑥

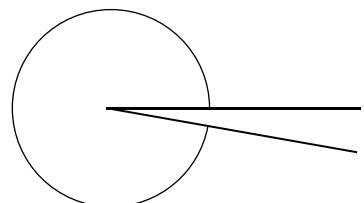

角の大きさ

角の大きさを測る [3]

問

次の角の大きさを分度器を使って測りましょう。

①

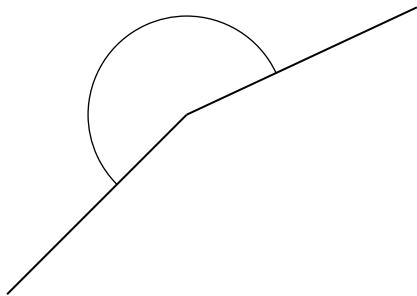

②

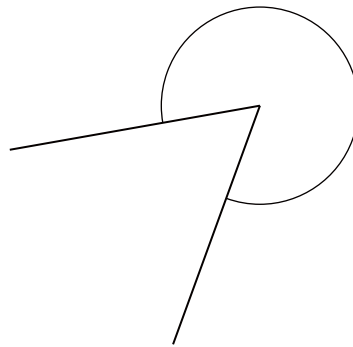

③

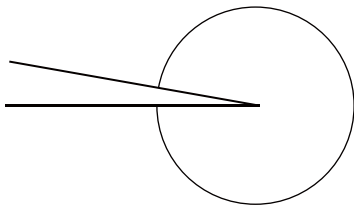

④

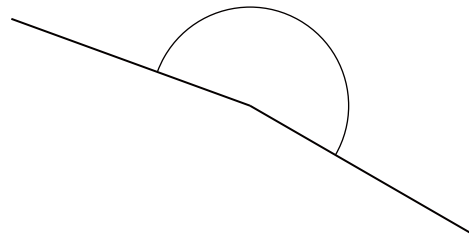

⑤

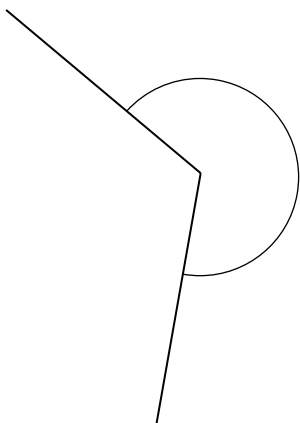

⑥

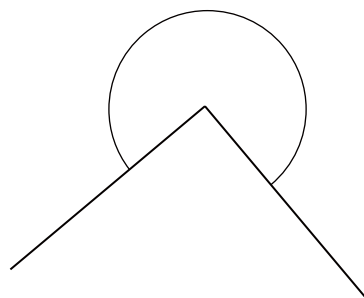

角の大きさの答え

角の大きさを測る [3]

問

次の角の大きさを分度器を使って測りましょう。

①

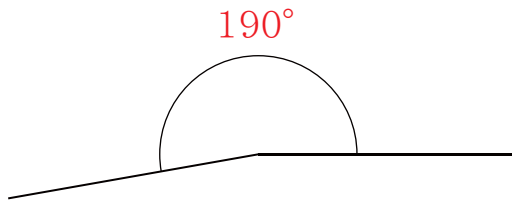

②

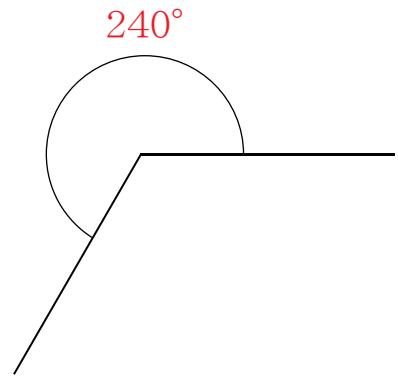

③

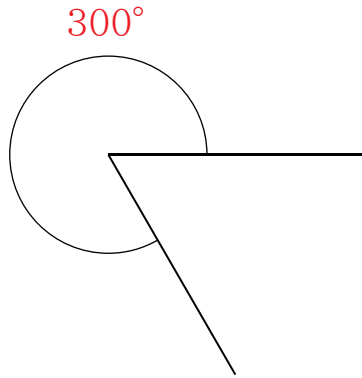

④

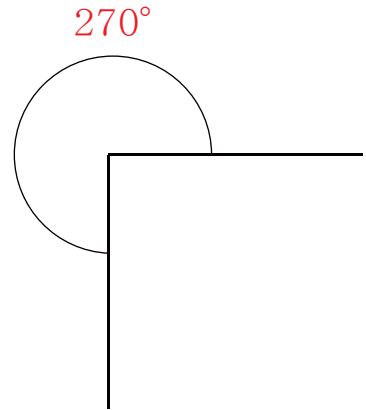

⑤

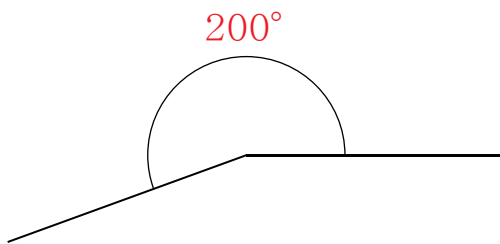

⑥

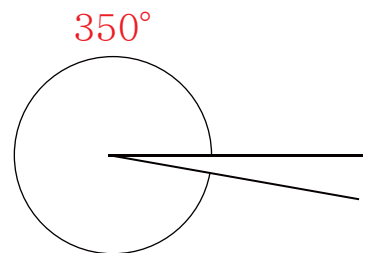

角の大きさの答え

角の大きさを測る [3]

問

次の角の大きさを分度器を使って測りましょう。

①

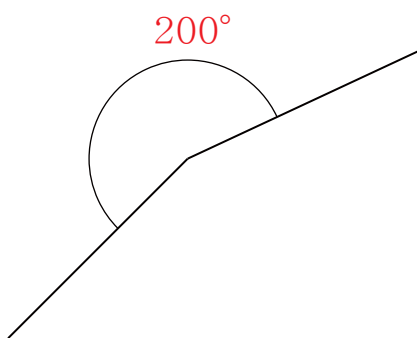

②

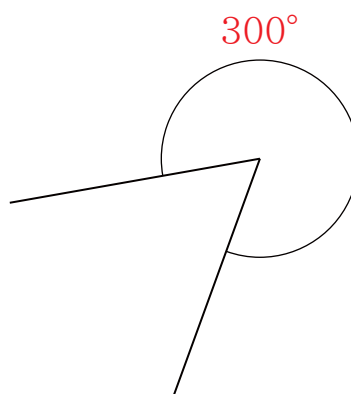

③

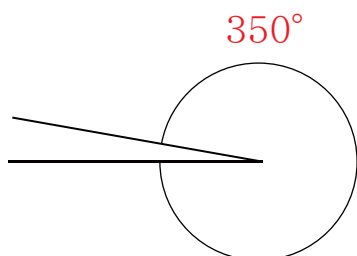

④

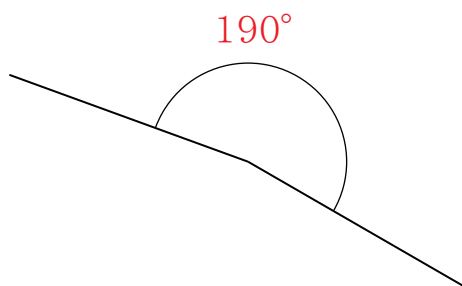

⑤

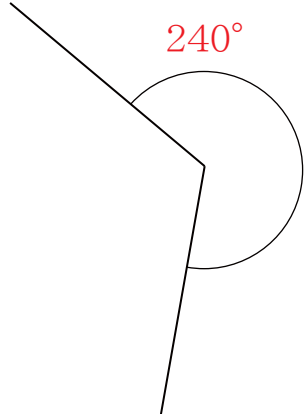

⑥

